

Bole is a range of high-quality IP65 bollard light with a contemporary and classic design. The fixture is with die-casting head, extrusion aluminum body and PC optical concept, Sophisticated surface finish gives a high end appearance of texture Thanks to perfect powder coating , Our bollards have IP65 certificate tough weather conditions , resistance seawater and corrosion. Bole range is available in Round / Square / Mushroom designs, and each design has 250mm, 600mm, 1000mm height. The professional optical solution offers a fully anti-glare and comfortable light uniformity, reaches 10Meter diameter wide light distribution but a very narrow dark zone under the fixture. Support for smart control such as DALI 2, Bluetooth and radar sensor. We offer 5 years warranty,main uses architectural addition to important business and commercial buildings, corporate headquarters, parks, recreational areas and gardens.

Features

Light emission 180° or 360°

No glare, Long range, Uniform light

Support for smart control functions

- DALI 2
 - Bluetooth
 - Radar Sensor
-

Lamp protection grade IP65/IK08

5 years warranty

Application Areas

commercial buildings, corporate headquarters, parks, recreational areas and gardens, etc.



Technical data

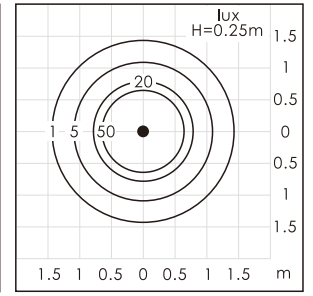
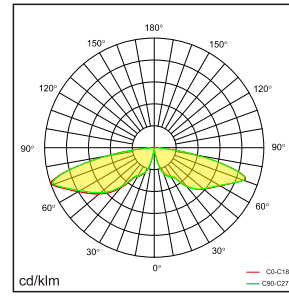
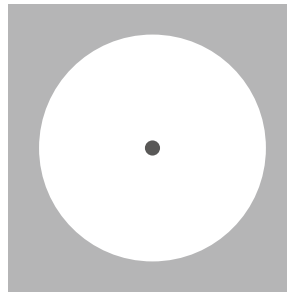
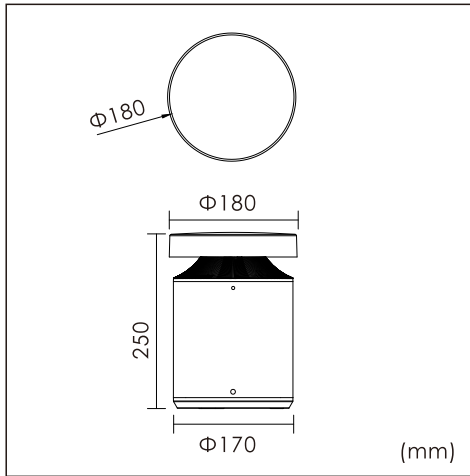

Item No.	B1BRO-12380-NN	B1BRO-12380-DN	B1BRO-12380-WM	B1BRO-12580-NN	B1BRO-12580-DN	B1BRO-12580-WM
Input Power	12W					
Input Voltage	AC200~240V					
Luminous Flux(±5%)	498 lm (3000K)					
Colour temperature	3000K			4000K		
Optic	360° distribution					
Total light flux at or above 90°	<3%					
Color Rendering Index	>80					
Life Time	L70(B50)50,000H					
Colour consistency SDCM	<3					
Dimming	NO	DALI	Wireless	NO	DALI	Wireless
Sensor	NO		Radar Sensor	NO		Radar Sensor
Housing Color	Black/Silver					
Fixture Materia	6063AL+ADC12+PC					
Protection Level	IP65/IK08					
Storage Temperature	-30°C~+60°C					
Working Temperature	-30°C~+45°C					
Net Weight	2.45kg					
Size	Φ180*250mm					
Package size	385*225*225mm (1PCS)					
20GP	1560 PCS					
40GP	3200 PCS					

Technical data

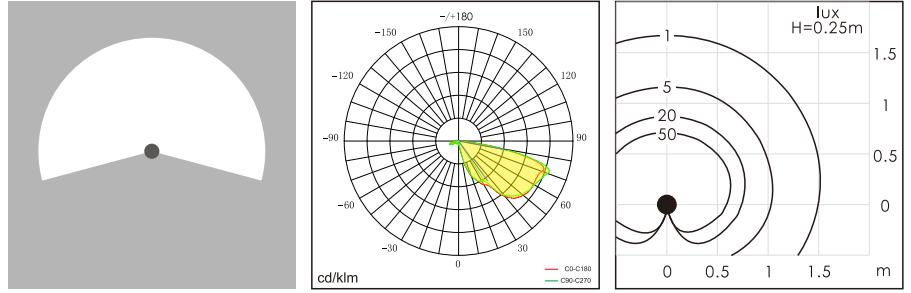

Item No.	B1BR3-12380-NN	B1BR3-12380-DN	B1BR3-12380-WM	B1BR3-12580-NN	B1BR3-12580-DN	B1BR3-12580-WM
Input Power	12W					
Input Voltage	AC200~240V					
Luminous Flux(±5%)	470 lm (3000K)					
Colour temperature	3000K			4000K		
Optic	Asymmetric 180° emission					
Total light flux at or above 90°	<3%					
Color Rendering Index	>80					
Life Time	L70(B50)50.000H					
Colour consistency SDCM	<3					
Dimming	NO	DALI	Wireless	NO	DALI	Wireless
Sensor	NO		Radar Sensor	NO		Radar Sensor
Housing Color	Black/Silver					
Fixture Materia	6063AL+ADC12+PC					
Protection Level	IP65/IK08					
Storage Temperature	-30°C~+60°C					
Working Temperature	-30°C~+45°C					
Net Weight	2.45kg					
Size	Φ180*250mm					
Package size	385*225*225mm (1PCS)					
20GP	1560 PCS					
	3200 PCS					

Technical data

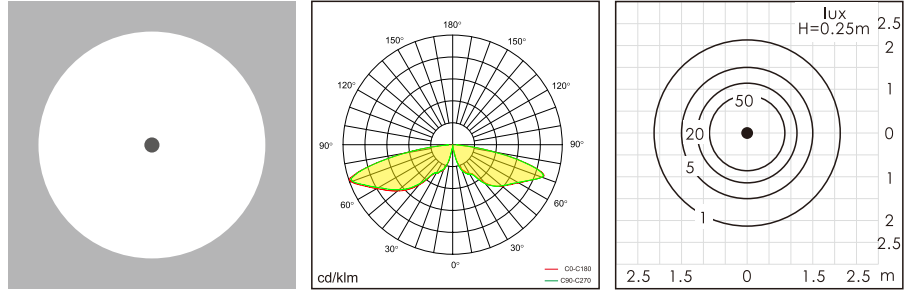

Item No.	B1BR0-24380-NN	B1BR0-24380-DN	B1BR0-24380-WM	B1BR0-24580-NN	B1BR0-24580-DN	B1BR0-24580-WM
Input Power	24W					
Input Voltage	AC200~240V					
Luminous Flux(±5%)	1124 lm (3000K)					
Colour temperature	3000K			4000K		
Optic	360° distribution					
Total light flux at or above 90°	<3%					
Color Rendering Index	>80					
Life Time	L70(B50)50.000H					
Colour consistency SDCM	<3					
Dimming	NO	DALI	Wireless	NO	DALI	Wireless
Sensor	NO		Radar Sensor	NO		Radar Sensor
Housing Color	Black/Silver					
Fixture Materia	6063AL+ADC12+PC					
Protection Level	IP65/IK08					
Storage Temperature	-30°C~+60°C					
Working Temperature	-30°C~+45°C					
Net Weight	2.45kg					
Size	Φ180*250mm					
Package size	385*225*225mm (1PCS)					
20GP	1560 PCS					
	3200 PCS					

Technical data

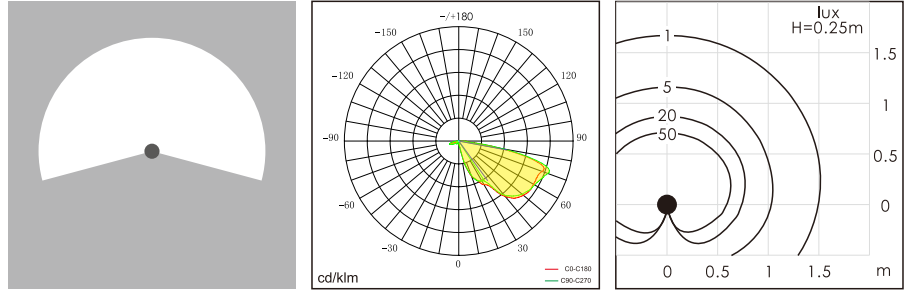

Item No.	B1BR3-24380-NN	B1BR3-24380-DN	B1BR3-24380-WM	B1BR3-24580-NN	B1BR3-24580-DN	B1BR3-24580-WM
Input Power	24W					
Input Voltage	AC200~240V					
Luminous Flux(±5%)	450 lm (3000K)					
Colour temperature	3000K			4000K		
Optic	Asymmetric 180° emission					
Total light flux at or above 90°	<3%					
Color Rendering Index	>80					
Life Time	L70(B50)50.000H					
Colour consistency SDCM	<3					
Dimming	NO	DALI	Wireless	NO	DALI	Wireless
Sensor	NO		Radar Sensor	NO		Radar Sensor
Housing Color	Black/Silver					
Fixture Materia	6063AL+ADC12+PC					
Protection Level	IP65/IK08					
Storage Temperature	-30°C~+60°C					
Working Temperature	-30°C~+45°C					
Net Weight	2.45kg					
Size	Φ180*250mm					
Package size	385*225*225mm (1PCS)					
20GP	1560 PCS					
	3200 PCS					

Technical data

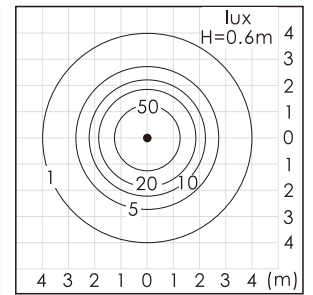
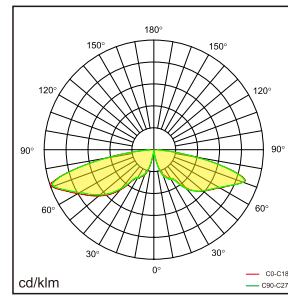
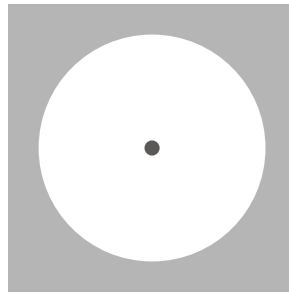
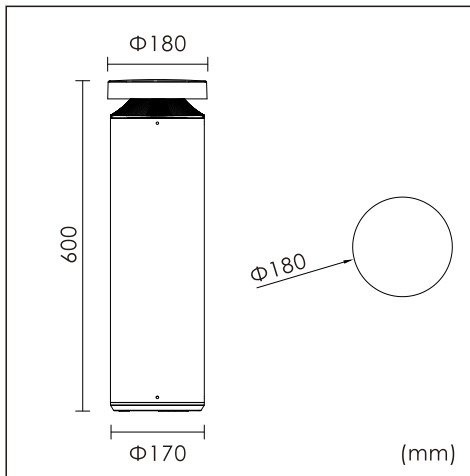

Item No.	B1BR1-24380-NN	B1BR1-24380-DN	B1BR1-24380-WM	B1BR1-24580-NN	B1BR1-24580-DN	B1BR1-24580-WM
Input Power	24W					
Input Voltage	AC200~240V					
Luminous Flux(±5%)	1124 lm (3000K)					
Colour temperature	3000K			4000K		
Optic	360° distribution					
Total light flux at or above 90°	<3%					
Color Rendering Index	>80					
Life Time	L70(B50)50,000H					
Colour consistency SDCM	<3					
Dimming	NO	DALI	Wireless	NO	DALI	Wireless
Sensor	NO		Radar Sensor	NO		Radar Sensor
Housing Color	Black/Silver					
Fixture Materia	6063AL+ADC12+PC					
Protection Level	IP65/IK08					
Storage Temperature	-30°C~+60°C					
Working Temperature	-30°C~+45°C					
Net Weight	3.8kg					
Size	Φ180*600mm					
Package size	735*225*225mm (1PCS)					
20GP	810 PCS					
40GP	1660 PCS					

Technical data

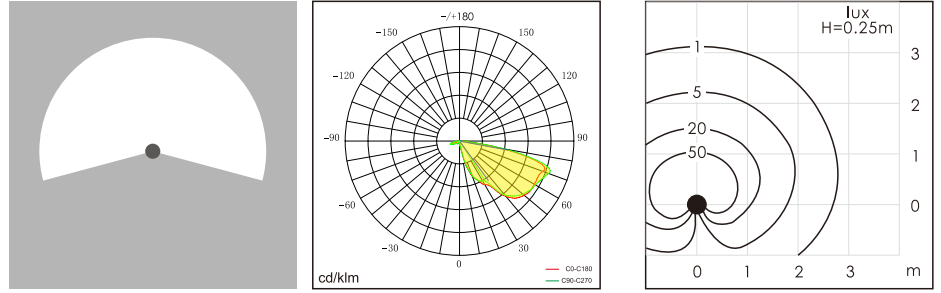

Item No.	B1BR4-24380-NN	B1BR4-24380-DN	B1BR4-24380-WM	B1BR4-24580-NN	B1BR4-24580-DN	B1BR4-24580-WM
Input Power	24W					
Input Voltage	AC200~240V					
Luminous Flux(±5%)	450 lm (3000K)					
Colour temperature	3000K			4000K		
Optic	Asymmetric 180° emission					
Total light flux at or above 90°	<3%					
Color Rendering Index	>80					
Life Time	L70(B50)50.000H					
Colour consistency SDCM	<3					
Dimming	NO	DALI	Wireless	NO	DALI	Wireless
Sensor	NO		Radar Sensor	NO		Radar Sensor
Housing Color	Black/Silver					
Fixture Materia	6063AL+ADC12+PC					
Protection Level	IP65/IK08					
Storage Temperature	-30°C~+60°C					
Working Temperature	-30°C~+45°C					
Net Weight	3.8kg					
Size	Φ180*600mm					
Package size	735*225*225mm (1PCS)					
20GP	810 PCS					
40GP	1660 PCS					

Technical data

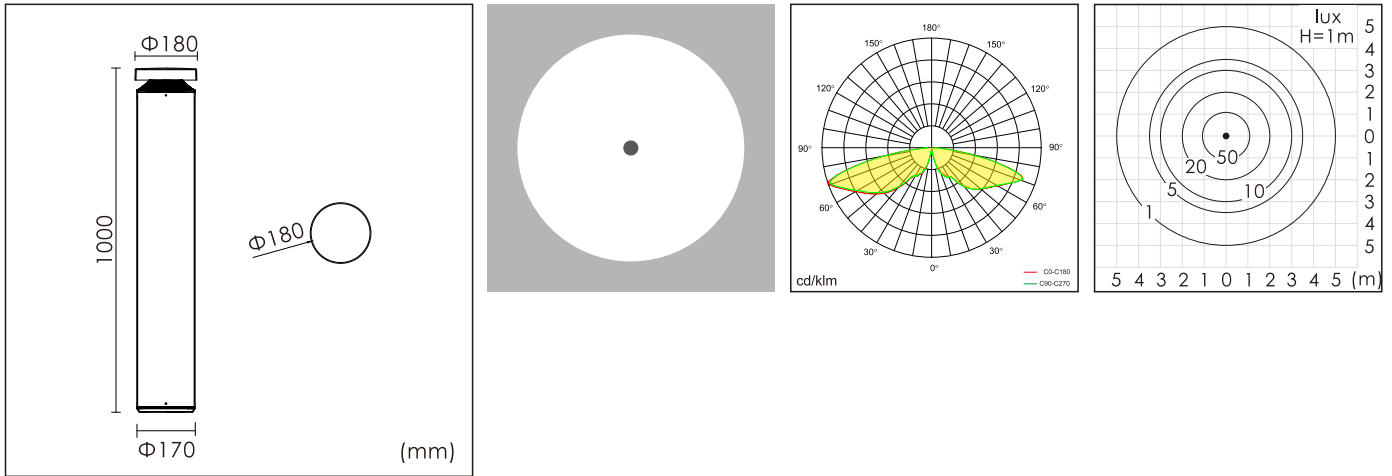

Item No.	B1BR2-24380-NN	B1BR2-24380-DN	B1BR2-24380-WM	B1BR2-24580-NN	B1BR2-24580-DN	B1BR2-24580-WM
Input Power	24W					
Input Voltage	AC200~240V					
Luminous Flux(±5%)	1124 lm (3000K)					
Colour temperature	3000K			4000K		
Optic	360° distribution					
Total light flux at or above 90°	<3%					
Color Rendering Index	>80					
Life Time	L70(B50)50,000H					
Colour consistency SDCM	<3					
Dimming	NO	DALI	Wireless	NO	DALI	Wireless
Sensor	NO		Radar Sensor	NO		Radar Sensor
Housing Color	Black/Silver					
Fixture Materia	6063AL+ADC12+PC					
Protection Level	IP65/IK08					
Storage Temperature	-30°C~+60°C					
Working Temperature	-30°C~+45°C					
Net Weight	5.35kg					
Size	Φ180*1000mm					
Package size	1135*225*225mm (1PCS)					
20GP	520 PCS					
40GP	1060 PCS					

Technical data

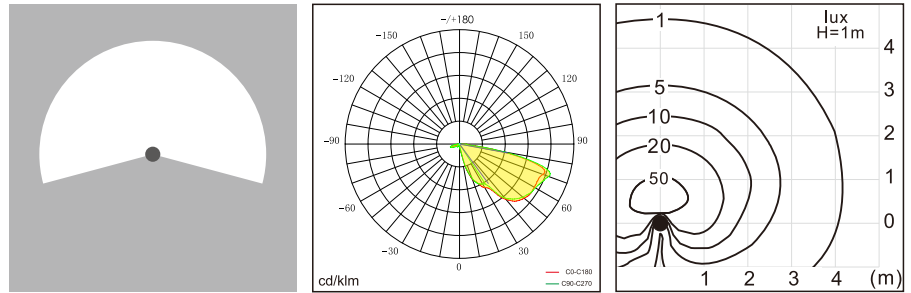

Item No.	B1BR5-24380-NN	B1BR5-24380-DN	B1BR5-24380-WM	B1BR5-24580-NN	B1BR5-24580-DN	B1BR5-24580-WM
Input Power	24W					
Input Voltage	AC200~240V					
Luminous Flux(±5%)	450 lm (3000K)					
Colour temperature	3000K			4000K		
Optic	Asymmetric 180° emission					
Total light flux at or above 90°	<3%					
Color Rendering Index	>80					
Life Time	L70(B50)50.000H					
Colour consistency SDCM	<3					
Dimming	NO	DALI	Wireless	NO	DALI	Wireless
Sensor	NO		Radar Sensor	NO		Radar Sensor
Housing Color	Black/Silver					
Fixture Materia	6063AL+ADC12+PC					
Protection Level	IP65/IK08					
Storage Temperature	-30°C~+60°C					
Working Temperature	-30°C~+45°C					
Net Weight	5.35kg					
Size	Φ180*1000mm					
Package size	1135*225*225mm (1PCS)					
20GP	520 PCS					
40GP	1060 PCS					

Accessories



L-type bracket
Φ225*154mm



Expansion screw
M8-Φ12*60mm



M682-B(3P)
IP68 Waterproof connector
72mm*21mm



M684-B(5P)
IP68 Waterproof connector
99mm*25mm



M685-Y
IP68 Waterproof connector
140mm*72mm